



MINIMAL
GARDEN

S/S 2025

SABRINA OLMO

Minimal Garden rappresenta una semplicità naturale, leggerezza e luminosità.

la collezione è caratterizzata da elementi tridimensionali e piatti, con impunture e abbinamenti di colori contrastanti tra loro ma caratterizzati da armonia. elementi della natura come i fiori sono nelle manipolazioni. i volumi sono scultorei ma non stravaganti.



IMPUNTURE

TRAVEL



DRAPING



BAGUETTE BAG

SLINGBACK

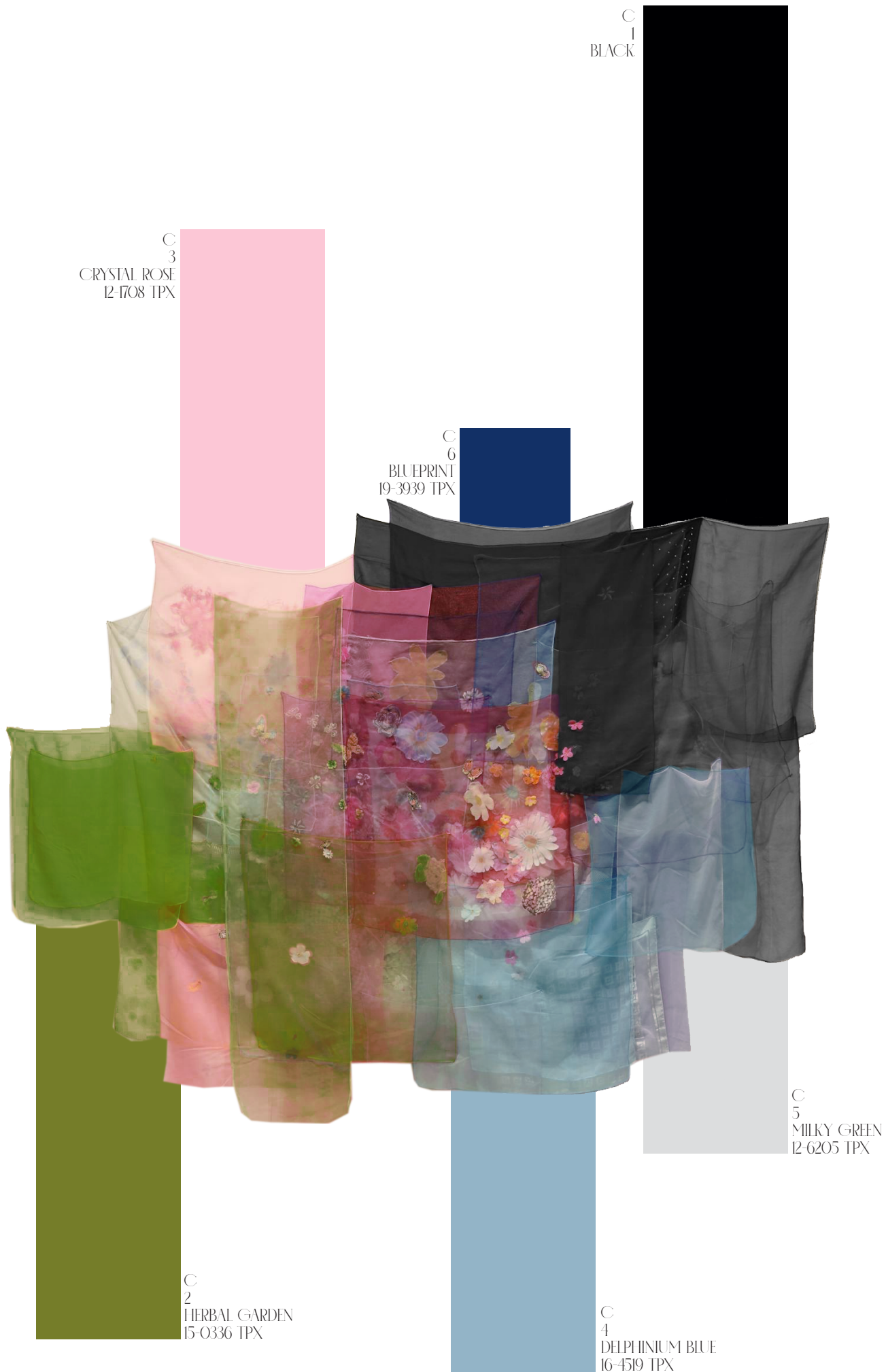

C
1
BLACK

C
3
CRYSTAL ROSE
12-1708 TPX

C
6
BLUEPRINT
19-3939 TPX

C
5
MILKY GREEN
12-6205 TPX

C
2
HERBAL GARDEN
15-0336 TPX

C
4
DELPHINIUM BLUE
16-4519 TPX



PELLE BOVINA

C1 - C2 - C3 - C4



FIBBIA IN METALLO
LUCIDO



OCCHIELLI IN
METALLO LUCIDO

X3



CERNIRA VISIBILE PER
BORSE

X5

C1 - C2 - C3 - C4



TACCO ABS
STAMPAIO EFFETTO
DRAPPEGGIO
PRESSATO



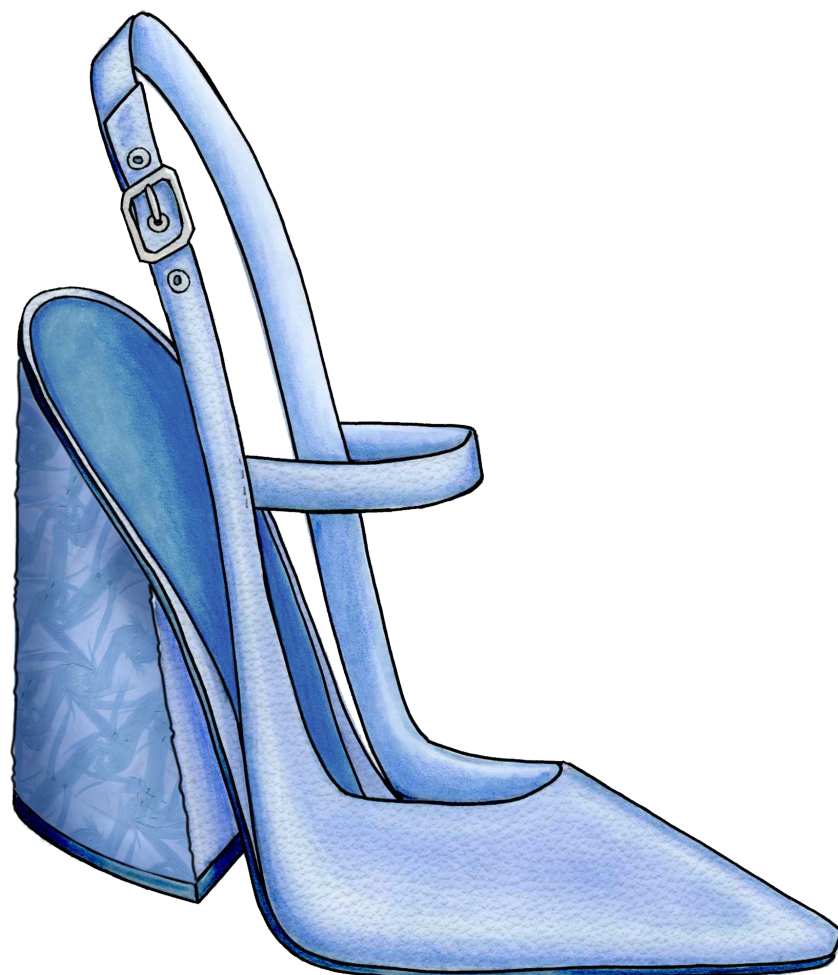

VARIANTE 1



VARIANTE 2



VARIANTE 3



VARIANTE 1

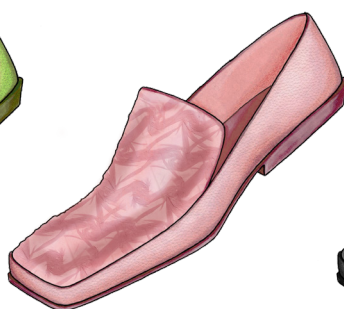

VARIANTE 2



VARIANTE 3



VARIANTE 1



VARIANTE 2



VARIANTE 3



VARIANTE 1



VARIANTE 1

descrizione

Slingback decolleté a punta, con fascetta anteriore stile mary jane. Realizzata in colore azzurro in pelle bovina. Presenta chiusura classica con fibbia e occhielli sul lato esterno della caviglia. Il tacco, di grandi dimensioni, è stampato per dare la forma tridimensionale del drappeggio pressato che ritroviamo negli abiti della collezione S/S 25, ed è alto 9cm. Le varianti colori di questa scarpa sono in rosa, verde e nero.

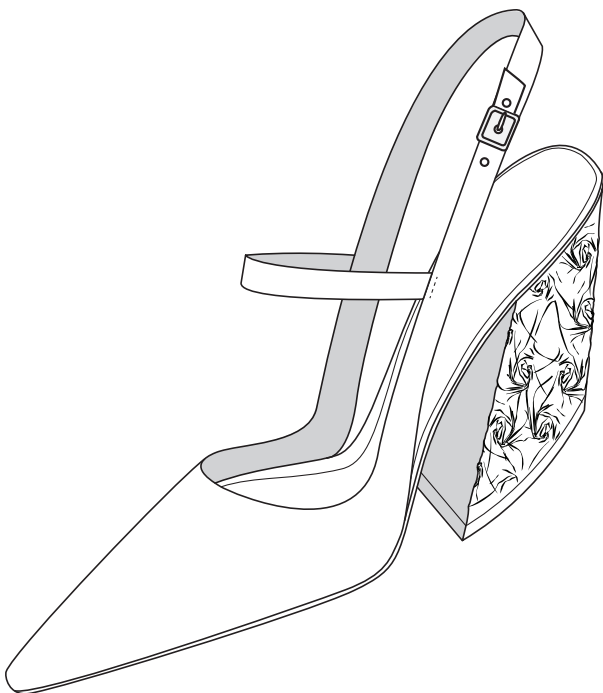
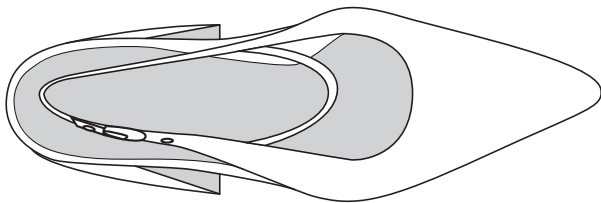
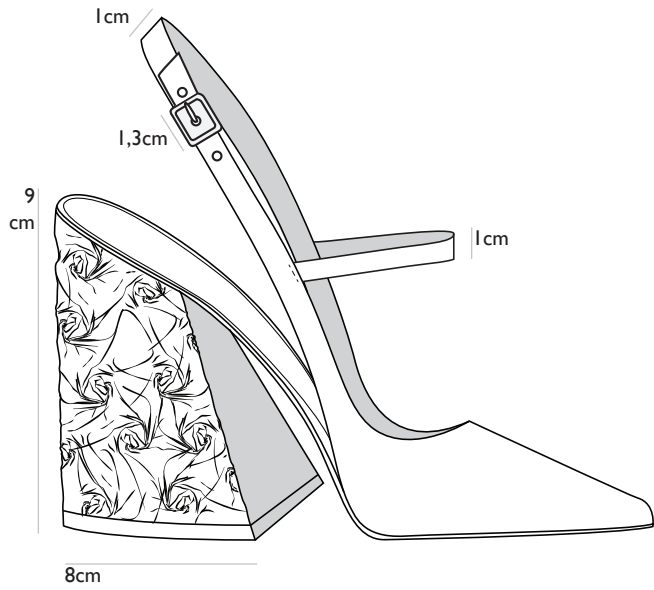

PELLE BOVINA

C1 - C2 - C3 - C4



FIBBIA IN METALLO LUCIDO



OCCHIELLI IN METALLO LUCIDO

X3

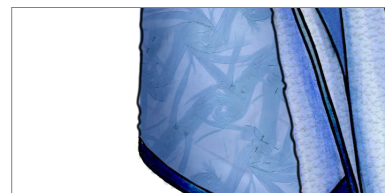

TACCO ABS STAMPATO EFFETTO DRAPPEGGIO PRESSATO

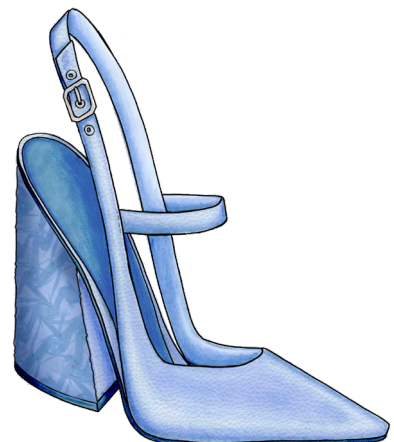

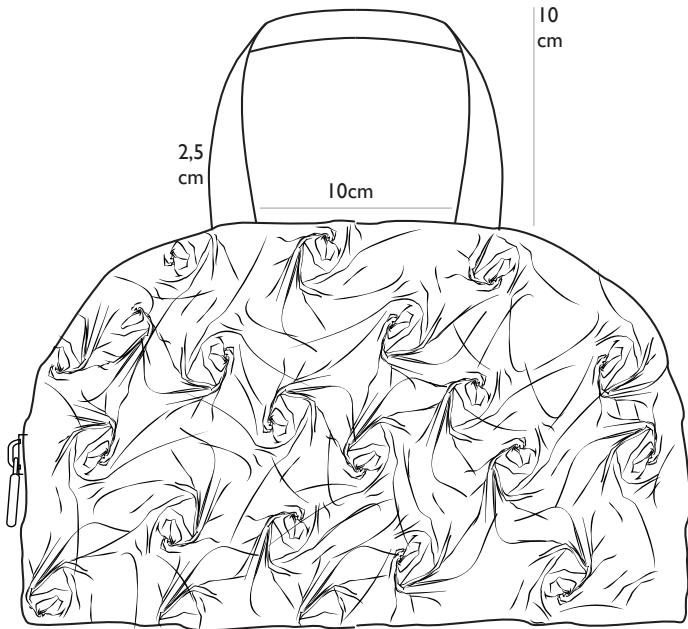
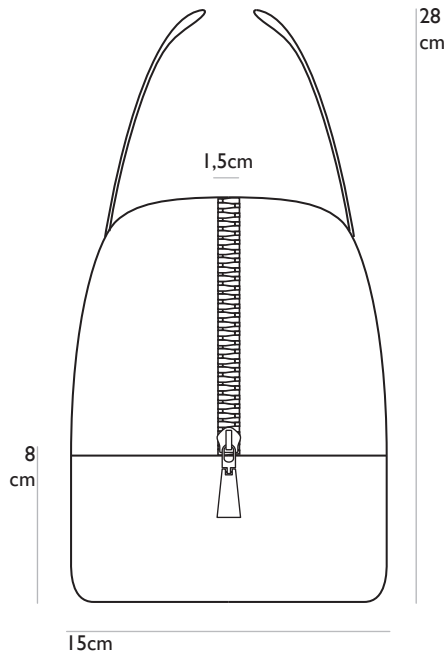

descrizione

Bowling bag con base rettangolare e due maniglie laterali. La borsa è realizzata in pelle bovina colore azzurro e le due facce laterali di essa sono ricoperte in tessuto taffetà azzurro (M1) drappeggiato; elemento che ritroviamo nella collezione d'abbigliamento S/S 25. la chiusura sulla parte superiore centrale della borsa è costituita da cerniera in metallo, con cursore a forma di trapezio.

Le varianti colore della borsa sono rosa, verde e nero.

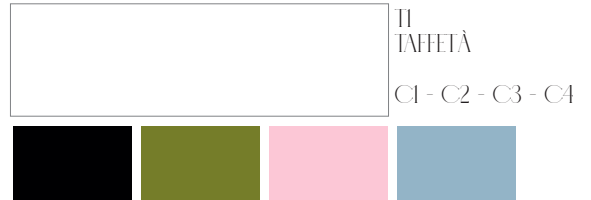

18cm



CERNIRA VISIBILE PER BORSE

X5

C1 - C2 - C3 - C4



30cm





TAFFETÀ



M I

drappaggio circolare in diverse direzioni, pressato e irrigidito

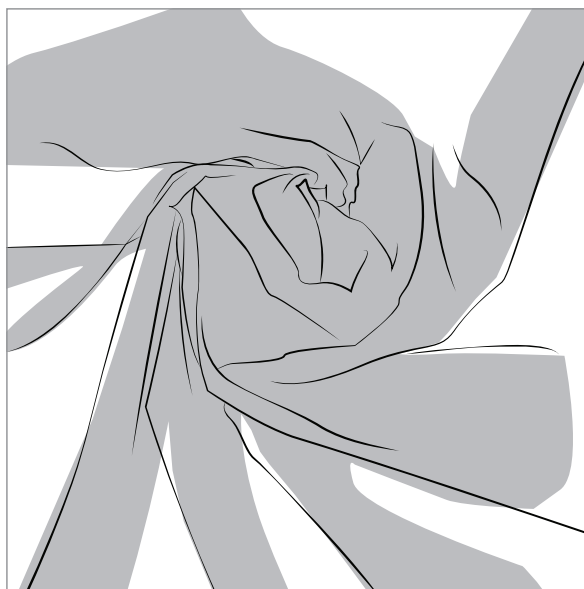

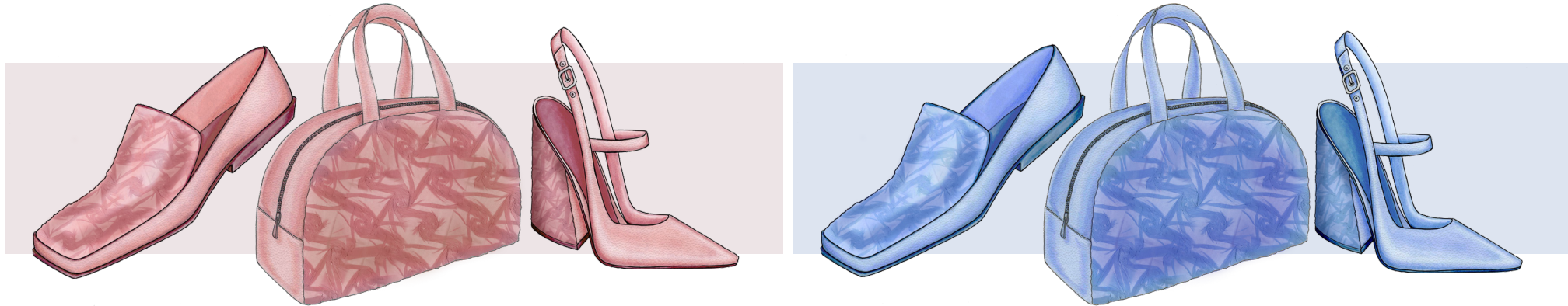



anthony meier artist, [online], available at: <https://www.anthonymeier.com/artists/wjim-hodges> [1-06-2024]



byron jorjorian fine art photography, [online] available at: <https://www.byronjorjorian.com/detail/5869.html>, [1-06-2024]

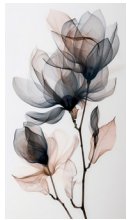

ozar_shop, [online] available at: https://www.instagram.com/ozar_shop/p/C6qVf8wtwcv/, [1-06-2024]



ASOS DESIGN Mini 90s Shoulder Bag, [online], available at: <https://www.refinery29.com/en-us/shop/product/mini-90s-shoulder-bag-8759869>, [1-06-2024]

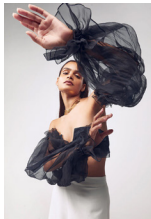

Mannat Gupta, Fashion avenue magazine, [online] available at: <https://fashionavenuenews.wordpress.com/2021/12/20/the-merak-collection-fresh-fabulous/>, [1-06-2024]



art&co, Stylists Monica Russell, [online], available at: <https://www.hartandco.com.au/artists/monica-russell/love-want-issue-27/>, [1-06-2024]



Ysabel Lemay Unity, 2011, [online], available at: <https://www.artsy.net/artwork/ysabel-lemay-unity-2>, [1-06-2024]



Woodgrain Free Motion Tutorial, Lori Kennedy, [online], available at: https://www.favequilts.com/Quilting-by-Machine/Woodgrain-Free-Motion-Tutorial#google_vignette, [1-06-2024]



yasmeen ghauri by Jacques Olivar, 1995, [online], available at: <https://it.pinterest.com/pin/262616221997613181/>, [1-06-2024]



istockphotos, [online], available at: <https://www.istockphoto.com/it/foto/texture-marmorata-verde-brillante-sfondo-mix-colore-verde-giallo-gm849258208-139361055>, [1-06-2024]